



REPAIRS HANDBOOK

Your guide to responsibilities and requesting repairs

Contents

- ▶ Repairs you are responsible for 1
- ▶ Other responsibilities you have 3
- ▶ Repairs we are responsible for 4
- ▶ You can report a repair in the following ways 5
- ▶ How long will it take..... 6
- ▶ About the repair visit 7
- ▶ Emergencies - what to do 9

Your guide to reporting repairs

- ▶ Baths, basins and showers..... 14
- ▶ Doors and frames..... 16
- ▶ Door locks and fittings 18
- ▶ Drains, wastepipes and gullies..... 20
- ▶ Electrics 22
- ▶ Floors and stairs 24
- ▶ Gutters..... 26
- ▶ Heating 28
- ▶ Kitchen fittings 30
- ▶ Roofs and chimneys..... 32
- ▶ Toilets 34
- ▶ Walls and ceilings..... 36
- ▶ Water supply and taps 38
- ▶ Windows 40

Handy hints

- ▶ 1. Dealing with blockages 42
- ▶ 2. Resetting a trip switch..... 44
- ▶ 3. Condensation..... 46

Repairs you are responsible for

Outside your home

- ▶ Your private garden. You are also required to work with other residents to be considerate and keep shared areas clean, tidy and free of obstruction.
- ▶ Greenery and small trees in your garden.
- ▶ Replacing clothes lines and posts, unless in a shared area.
- ▶ Keeping gully grids clear.
- ▶ Any fixtures or features in your garden that you have installed, for example decking or sheds.

Inside your home

Appliances (for example washing machines and cookers)

- ▶ Installing and repairing all appliances, including their related supply and drainage pipes.

Blockages

- ▶ Clearing blockages in toilets, basins, baths and your own appliances (see **Handy hint 1** on page 42).

Bathrooms and kitchens

- ▶ Handles, hinges and catches on kitchen units.
- ▶ Cleaning extractor fan vents.
- ▶ Toilet seats.
- ▶ Plugs and chains on baths, basins and sinks.
- ▶ Shower heads and hoses, shower rails and curtains.

Doors, windows and locks

- ▶ Additional security, including extra locks or reinforcement bars.
- ▶ Adjusting doors when you have new floor coverings fitted.
- ▶ Broken glass in windows, unless you have a crime reference number for any vandalism or a break-in.
- ▶ Doors inside your home, including handles, hinges and locks. Many internal doors are designed to be fire doors; you should not remove door closers. If you are unclear whether a door is a fire door, you should contact us before carrying out repairs.
- ▶ Door knockers, handles and bells (excluding any in shared areas or any that are adapted for disabled users).
- ▶ New keys or changing locks when you lose your keys, get locked out or a lock has broken.
- ▶ Oiling of hinges on windows and doors to ease them.
- ▶ Draught proofing.

Other

- ▶ Bleeding radiators.
- ▶ Filling in minor cracks or holes (smaller than 3mm) in internal walls.
- ▶ Floor coverings and finishes, including laminate flooring. We are not responsible for unavoidable damage caused to the flooring in order to carry out maintenance works. We strongly recommend you do not install solid, fixed and/or difficult to remove floor coverings.
- ▶ Hooks, curtain rails, blinds and shelves.
- ▶ Internal decorating.
- ▶ Replacing light bulbs and fluorescent tubes (excluding ones in sealed light fittings and any in shared areas).
- ▶ Testing and cleaning smoke detectors and changing the back-up battery on stand-alone detectors that you have fitted (we are responsible for ones we have fitted).
- ▶ TV sockets and aerials, except for communal aerials.

Other responsibilities you have

- ▶ If damage is caused by you, a member of your household or a visitor to your home, it is your responsibility to repair it.
- ▶ If your home is damaged by a third party, we will make your home safe but we will only carry our further work if you have a crime reference number (not an incident number).
- ▶ Contents insurance. We insure the building that you live in but your personal belongings are your responsibility. For example if there is a water leak, you are responsible for any damage to your decorations, fittings and belongings. The National Housing Federation's My Home Contents Insurance provides affordable contents insurance to all tenants. You can all them directly on **0845 337 2463** or visit **www.comparethemarket.com** for a list of providers.
- ▶ You must seek permission before making alterations to your home and they must be carried out by registered providers to ensure that any works meet current safety standards. For more information please see the Alterations to your home factsheet on our website.
- ▶ You must allow our contractors into your home to perform repairs, necessary inspections and gas safety checks. We are legally required to carry out regular gas safety checks at least once every 12 months.
- ▶ Letting us know as soon as a repair is needed and taking action to prevent it from getting worse.
- ▶ Setting heating and boiler controls correctly.
- ▶ Resetting trip switches. See **Handy hint 2** on page 44).
- ▶ Ventilating your home and taking action to prevent and reduce condensation and pipes from freezing and bursting (see **Handy hint 3** on page 46).
- ▶ Keeping your home clean and tidy to a reasonable standard and leaving the property without any outstanding repairs at the end of your tenancy.

Repairs we are responsible for

Outside your home

- ▶ Shared areas, including shared gardens.
- ▶ Decorating the outside of the building.
- ▶ Doors and door entry systems.
- ▶ Drains, wastepipes, gutters , gullies and manholes.
- ▶ Fences, gates, paths and steps.
- ▶ Garages, stores and garage doors.
- ▶ Roofs and chimneys.
- ▶ Large trees where root growth may cause damage to your home or the building.

Inside your home

- ▶ Baths, basins, taps (including tap washers), showers (excluding shower heads and hoses, rails and curtains) and toilets (excluding blockages and toilet seats).
- ▶ Drains and wastepipes.
- ▶ Electrics, electric wiring, sockets and switches.
- ▶ Entrance doors, door frames, door locks and fittings (excluding additional security).
- ▶ Fireplaces and smoke detectors that we have fitted.
- ▶ Floors (excluding floor coverings and finishings), ceilings and stairs.
- ▶ Heating and hot water systems.
- ▶ Radiators (excluding bleeding radiators).
- ▶ Shared areas.
- ▶ Skirting boards.
- ▶ Wall tiles, windows (excluding broken glass), window sills and ventilation.
- ▶ Water or gas pipes. Sometimes your electricity, water or gas supplier is responsible for a problem. If this is the case, we will tell you.

You can report a repair in the following ways

Phone

- ▶ Our normal office hours are between 8.30am - 5.00pm Monday - Friday, except bank holidays. You can contact us during this time on **020 8354 5500**.
- ▶ Outside of these hours and on public holidays, there is a special service for **emergency repairs only**. To contact the emergency repair service please call **020 8354 5500** and follow the instructions in the message. Your call will automatically be transferred to our emergency out-of-hour services. Please note if an operative is sent out to you and they find it is not an emergency you will be recharged the cost of the visit.

Online or email

You can also report a repair online or by email by filling out a form on our website. Please note for emergency repairs it is better to phone us so we can talk to you directly.

- www.octaviahousing.org.uk (not for emergency repairs)

MyOctavia mobile phone app

The easiest way to keep track of any repairs you have reported is by using our app. You can view any repair that you have reported for your property as well as all the communal repairs reported for your block. You can also see any updates on the progress of a repair, targeted completion date and the name of the contractor who will be visiting the property.

Other useful numbers

Reporting gas repairs

- ▶ If you smell gas or if a gas leak is suspected, immediately switch off the gas supply at the meter, do not use electrical appliances or switches, do not light naked flames.
- ▶ Call National Grid straight away on freephone **0800 111 999** – use a telephone outside of your building (even using a mobile phone could spark an explosion).
- ▶ Call us to let us know on **020 8354 5500**.

Whichever way you contact us, we will want to know enough information to get the right person out to you first time:

- ▶ Your name, address and a contact number so we can ring you back.
- ▶ Whether there are things we need to know about you such as if you're hard of hearing, or you need time to get to the door.
- ▶ As much as you can tell us about what needs to be done.

Customer Contact Team 020 8354 5500

If you need any further information about this handbook or any other service that we offer, please call the Customer Contact Team on **020 8354 5500**.

How long it will take

We group repairs into response time categories. The times are measured from the date you report the problem to us. We aim to complete the job within the response times given below.

- ▶ **Emergency: we will get someone to your home as soon as possible and make the situation safe within 24 hours.** This is for repairs that are needed to remove immediate danger to people, to make the property secure or to avoid flooding or major damage to the property. For example, flooding or burst pipes, total electrical failure or an unsecured front door are emergency repairs.
- ▶ **Urgent: we will arrange an appointment and do the work within 5 working days.** This is for work that needs to be done quickly but where there is no immediate health, safety or similar risk. For example, faulty electrical components (not causing health and safety concerns) or broken door entry systems.
- ▶ **Routine: we will arrange an appointment and do the work within 15 working days.** This is for work inside or outside your home where the problem does not cause immediate inconvenience or present a danger to occupants or the public, but should not wait for planned work. For example, leaking taps, damage to fences or a broken extractor fan.
- ▶ **Planned work: we will advise you of a timescale when these works are due to take place.** This is when we carry out certain non-urgent works to several homes together rather than as individual jobs, as this is more efficient.

These times are subject to change if we have delays in ordering a part but we will keep you informed if this happens.

About the repair visit

Preparations you may need to make

- ▶ Make sure your prepayment meter for electricity or gas is in credit. Contractors may need to use these to carry out checks.
- ▶ Before the contractor arrives, you will need to make sure the area where they are going to work is clear and safe. If you are having difficulties arranging this, please let us know.
- ▶ Make sure all breakables and valuables are cleared away.
- ▶ Our contractors and staff must have a smoke-free environment to work in. You should stop smoking before they arrive and not smoke while they are working.
- ▶ If you cannot keep the appointment, please let us know as soon as possible. You may be charged if you miss a confirmed appointment.

When the contractor arrives

- ▶ Make sure the contractor shows you their identity card before you allow them in. If in doubt, please contact us.
- ▶ An adult (over 18) must be present while the contractor is in your home.
- ▶ Keep your children and pets away from the work area.
- ▶ If the contractor can not complete all the work on the first visit they will call the office to arrange a further appointment with you before they go.
- ▶ If the weather conditions are poor, the contractor may not be able to carry out the work and will make an appointment with you to return.

Our contractors will:

- ▶ explain what they are going to do and discuss how this will affect you;
- ▶ do everything reasonable to protect your home from damage, dust and paint;
- ▶ make sure that the materials and tools they use do not cause danger to anyone in your home;
- ▶ make sure that electricity, water and gas are connected at the end of the day, unless it is unsafe to do so;
- ▶ close doors and gates when coming in and out of your home; and
- ▶ clear their rubbish from your home.

Contractors are not allowed to:

- ▶ smoke or play radios in or around your home;
- ▶ use mobile phones during their work, unless it is to deal with matters relating to the work;
- ▶ receive gifts (including money) from residents or members of the household;
- ▶ keep keys to your home; or
- ▶ carry out private work for you.

They must ask your permission to:

- ▶ use your phone;
- ▶ use your toilet;
- ▶ go into other rooms in your home;
- ▶ take their lunch break in your home; or
- ▶ use your electricity supply.

Emergencies - what to do

We recommend that you fill in the boxes below in case of emergencies and make any notes in the space provided at the end of this section.

Gas (smell, leak or fumes)

- ▶ Do not switch on/off lights or appliances.
- ▶ Do not smoke or light matches.
- ▶ Open the windows.
- ▶ Turn off your gas supply by turning the handle to the horizontal position (see picture below).
- ▶ Call National Grid on **0800 111 999** – use a telephone outside of your building (even using a mobile phone could spark and explosion).
- ▶ Call us to let us know. Please note that air vents and bricks in kitchens are there for your safety. Please do not block these at any time.

Where is the gas meter?

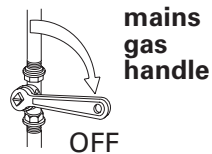

Smoke (fumes or your smoke detector alarm sounds)

- ▶ If you can smell or see smoke, call **999** immediately.
- ▶ If there is no sign of smoke or fire, check whether the alarm has been set off by something else.

Fire

If there is a fire in your flat or house

- ▶ Dial **999** and inform the fire brigade.
- ▶ Close doors, if possible, to prevent smoke and fire spreading.
- ▶ Stay calm and get everyone out.
- ▶ Make your way out of the building by using the emergency exit staircase.
- ▶ Do not stop or go back for anything.
- ▶ When you are safe, call us to let us know.

If there is a fire in your block of flats

- ▶ Dial **999** and inform the fire brigade. Unless they tell you to evacuate, you will normally be safe if you stay in your flat, unless heat and smoke are affecting you.
- ▶ Close doors and windows to stop smoke getting in. If smoke gets in, leave immediately and close the door behind you.
- ▶ Stay near a window and listen to instructions from the fire brigade.

Shared areas such as lifts, lobbies, balconies, corridors and staircases must not be obstructed with rubbish or belongings. If there is a fire, they can stop the fire brigade from doing their job properly. These items are easily set alight and can block escape routes for you or your neighbours.

You should always familiarise yourself with your fire procedure, which will be found by the main entrance door.

Electricity (fittings or appliances sparking, flickering, giving off shocks or no electricity at all)

- Turn the mains switch on the consumer unit to OFF.
- If you have a power cut, contact your electricity supplier.
Write the number down here
- If you have any other problems with your electricity, then contact us using the details on page 5.

Where is the consumer unit (fuse box)?

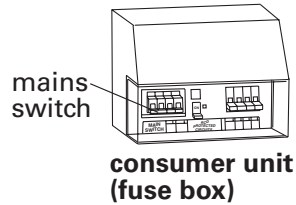

Water (burst pipe, flooding or no water at all)

- To stop flooding, turn the mains stoptap to the right (clockwise ↻) or press the surestop switch (if there is one).
- If you need to shut off the supply of water to a fitting, such as a toilet or basin, you can use the isolation valve on the pipe leading to it (if there is one fitted).
- If you have no water supply at all coming into the property, phone your local water company.
Write the number down here.....

Where is the mains water stoptap or surestop switch?

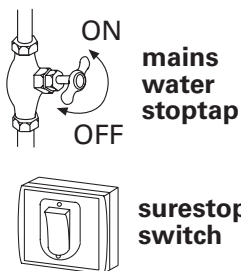

Where are the isolation valves?

1

2

3

4

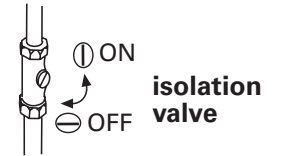



YOUR GUIDE TO REPORTING REPAIRS

Baths, basins and showers

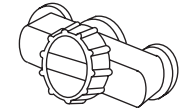
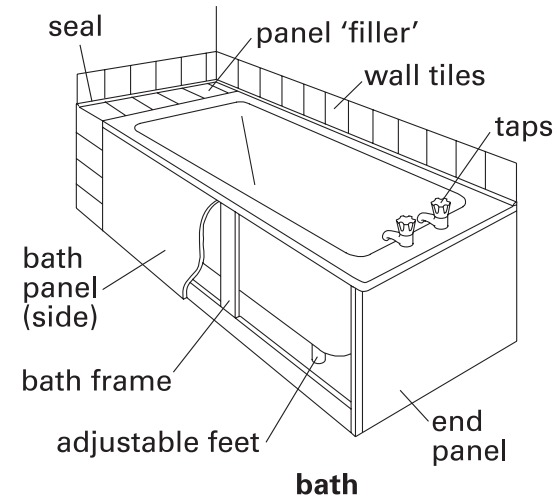

shower mixer valve



shower ceiling switch

combined tap and shower attachment

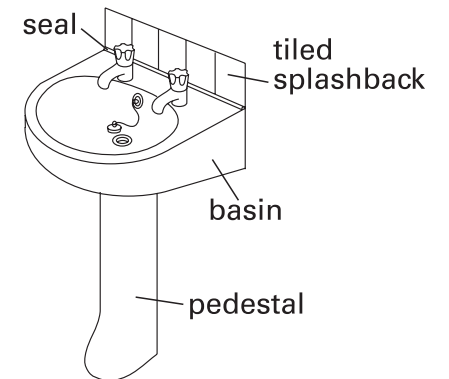
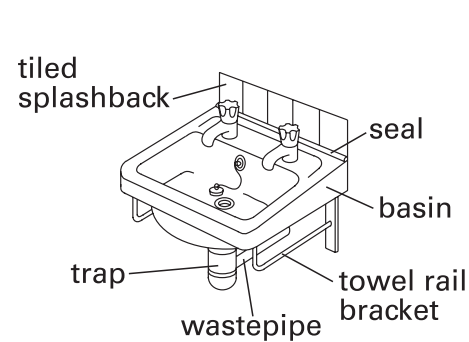
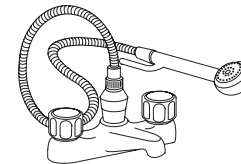

wash hand basins

What we need to know:

Baths and basins

- What is the problem: bath cracked, chipped, unstable; seal leaking; wastepipe leaking or blocked?
- What is it made of?
- If it is leaking, where is the leak showing?
- If it is blocked, are both the bath and basin blocked?
- Can you still use it? Is it safe?
- If the problem is with the bath panel, is it the side panel or the end panel?

Showers

- What is the problem: shower not working, leaking or a part broken; shower ceiling switch not working?
- Is it an electric-powered shower? If not, is it a shower unit with a mixer valve or is it a combined tap and shower attachment on the bath?
- What type of tray does it have: ceramic or plastic?

Advice. If you have had any adaptations made to your bathroom, please let us know when reporting your repair.

For **blockages** see **Handy hint 1** on page 42.

For **drains** and **wastepipes** see page 20.

For **taps**, **pipes** and **water** see page 38.

For **toilets** see page 34.

Doors and frames

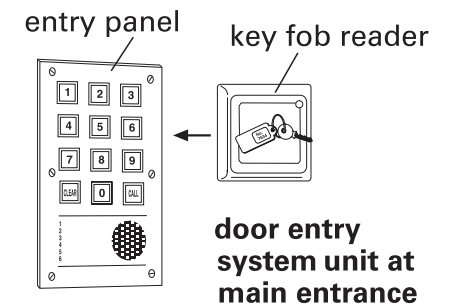
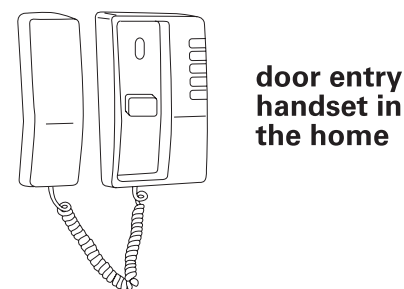
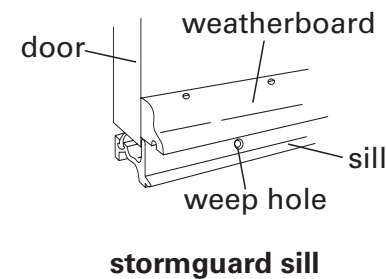
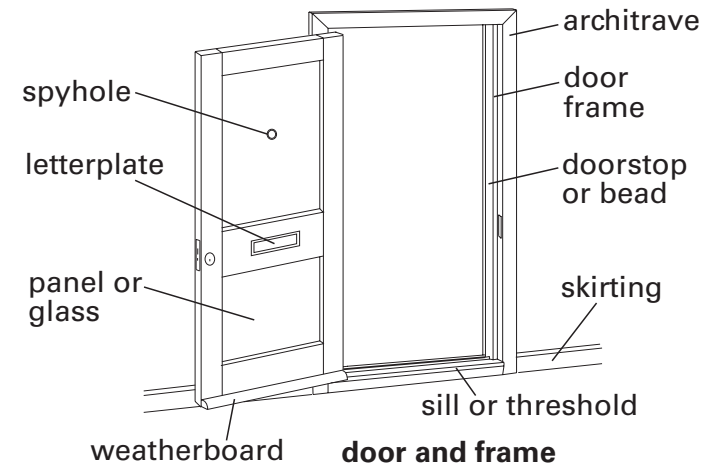

What we need to know

Doors and frames

- What is the problem: door sticking, not closing properly, damaged, draughty or rain coming in underneath; frame loose; hinge coming loose?
- Which door is it: front, back, side, patio, or a garage or shed door?
- Is it a shared or common entrance door?
- What is it made of: wood, plastic (upvc) or metal?
- If it is damaged, which part needs repairing or replacing?
- Can you lock the door? Is your home secure?

Door entry system

- What is the problem: door not unlocking, telecom not working (you or your visitor cannot hear anything that is said), buttons not working?
- Is the problem with the handset in your home or with the unit at the main entrance?

Specially adapted bells or bells in shared areas

- Where is the bell?
- Is it specially adapted for disabled users?
- Is it powered by a battery or is it wired into the mains electricity?

Spy holes, chains and other fittings

- Did you or a previous resident fit this or was it provided by us?

Advice. If the repair is on a door inside your home, please see page 1 for **Repairs you are responsible for.**

For **locks, latches** and **other door fittings** see page 18.

Door locks and fittings

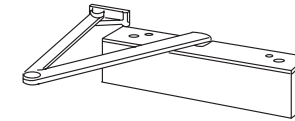

overhead door closer

single chain
perko door closer

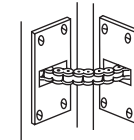

door handle
without lock

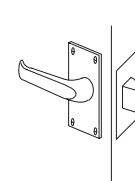

rim lock

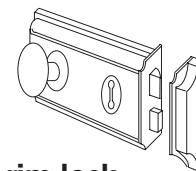

rising butt hinge butt hinge
door hinges

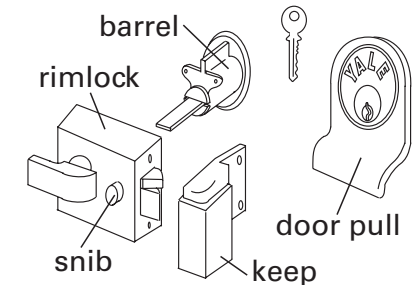

cylinder rim nightlatch
(Yale or Union)

lever handle latch
keep
dead lock
mortice lock

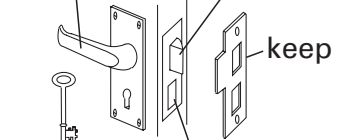

multi-point
lock



cylinder mortice
lock (snib inside)

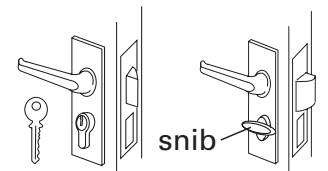

door knob

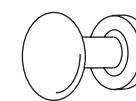

barrel
bolt

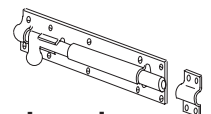

What we need to know

Locks

- What is the problem: key lost (see **Advice** below) or left inside, lock stiff, broken or not working; latch not fitting properly into the keep?
- What type of lock is it?
- Which door is it on?

Door closers

- What is the problem: part come loose or broken; door not closing, slamming or closing too fast?
- What type is it: overhead or perko?
- What door is it on?

Drains, wastepipes and gullies

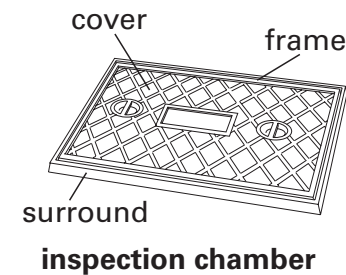
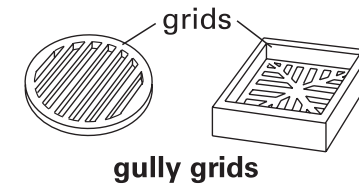
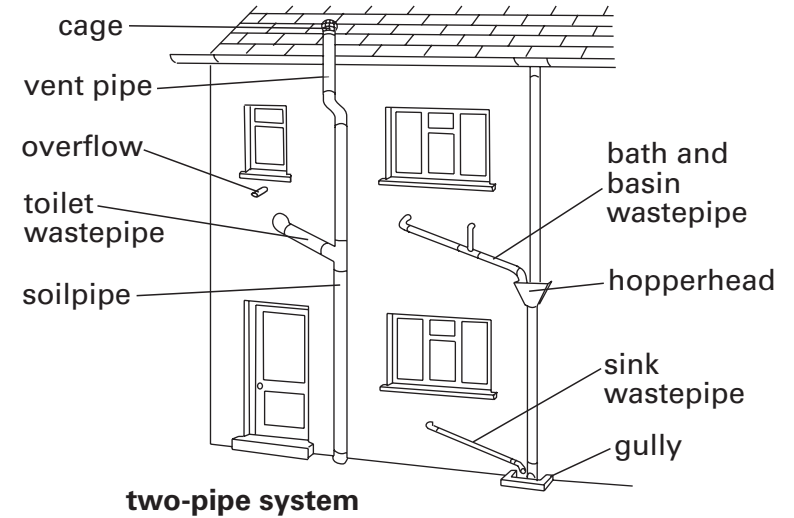

What we need to know

Main drains

- ▶ What is the problem: drain smelling or overflowing; inspection chamber (manhole) cover loose, damaged or missing?
- ▶ Where is the inspection chamber (manhole): in the garden, on a path, on the pavement or in the road?

Wastepipes

- ▶ What is the problem: wastepipe leaking or smelling; water not flowing away; trap or trap seal broken or loose?
- ▶ Which fitting is the waste coming from: bath, basin, sink, shower or toilet?
- ▶ If it is blocked, are any other fittings blocked too (bath, basin, sink, shower or toilet)?
- ▶ If it is leaking, where is the leak showing?

Soilpipes

- ▶ What is the problem: soilpipe leaking, damaged or blocked; waste backing up into the toilet?
- ▶ What is it made of: plastic or cast iron?
- ▶ Where is it? How easy is it to get access to?

Gullies

- ▶ What is the problem: gully blocked, grid loose or missing, surround damaged or missing?
- ▶ Where is the gully: beside the property, on a path or in the road?
- ▶ What shape is the grid: round or square?
- ▶ What is the grid made of: metal or plastic?
- ▶ Is the surround in which it sits made of metal or concrete?

Advice. For help with blockages, see **Handy hint 1** on page 42.

Electrics

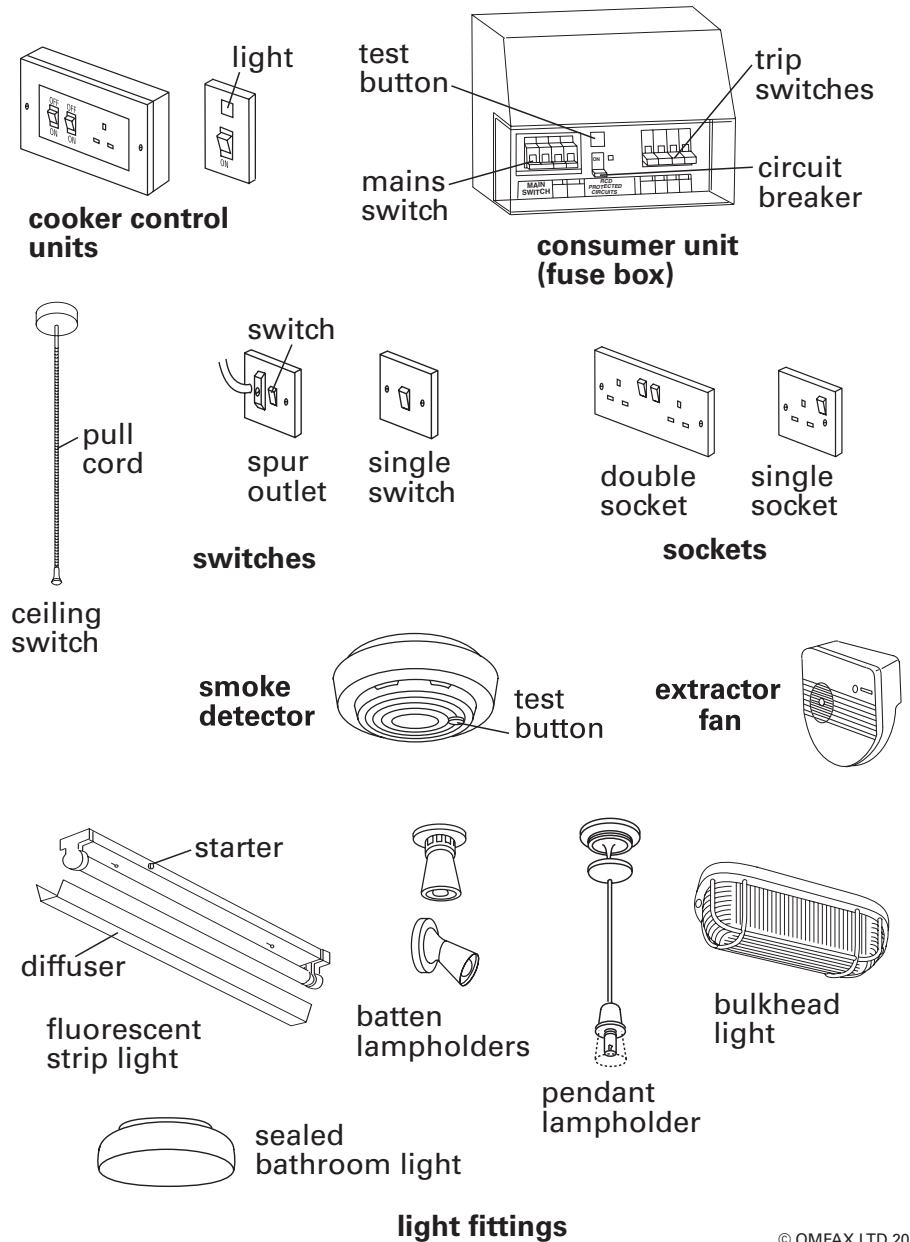

What we need to know

Lights outside the building or in shared areas

- ▶ What is the problem: not working, flickering, part is loose, missing or damaged?
- ▶ Where is the light?
- ▶ What type of light fitting is it: bulkhead, fluorescent strip light or another type?
- ▶ Does the light fitting have an I.D. number on it?
- ▶ Is it on a timer switch?

Lights and power inside the home

- ▶ What is the problem: no lights or power working anywhere in the home; no lights and/or power working in part of the home; a light fitting, switch or socket not working, loose, broken, sparking or giving you a shock when you touch it?
- ▶ If there are no lights working at all, are nearby homes or buildings also without lights? Are the power sockets also not working?
- ▶ If the lights or power are not working in part of the home, have you checked whether something has caused it to trip off? You should try to reset the trip switches. See **Handy hint 2** on page 44.
- ▶ If it is a problem with a light fitting, what type is it? Have you tried a new light bulb?
- ▶ If it is a fluorescent light, is it shimmering, flickering or only lighting at the ends? Have you tried putting in a new starter and/or a new fluorescent tube?
- ▶ Is there water leaking onto any switches, sockets or fittings?
- ▶ Are there any sparks coming from any switches, sockets, or fittings, or are there any bare wires showing?

Floors and stairs

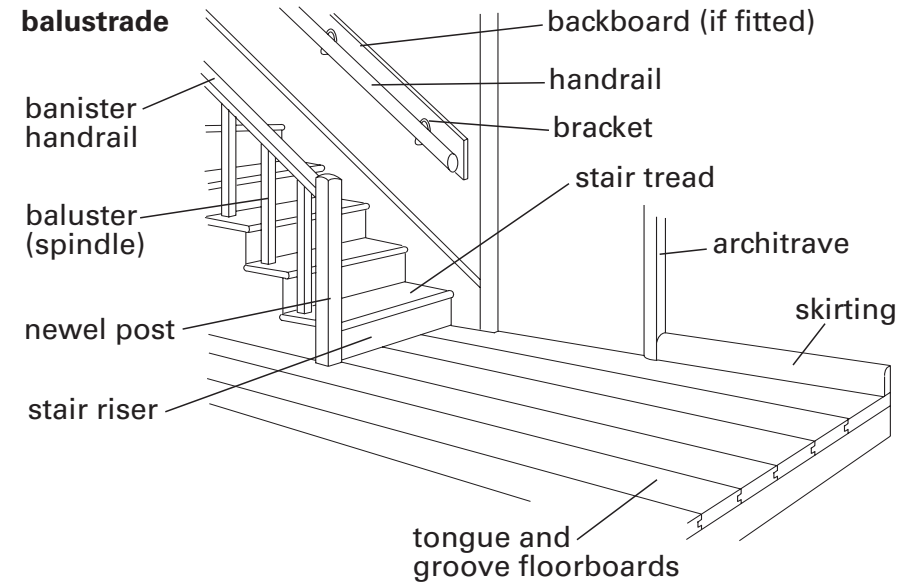

stairs and wooden floor

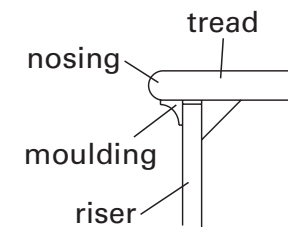

step details

What we need to know

Floors

- ▶ Where is the problem?
- ▶ What is the problem: floorboard loose, squeaking or broken; floor tiles cracked or loose; floor covering lifting or damaged; skirting loose, missing or damaged; damp on the floor?
- ▶ What is the floor made of: floorboards, chipboard or concrete?
- ▶ What type of floor covering is it, for example: quarry or clay tiles (usually red), plastic (vinyl) tiles or sheeting, non-slip flooring?
- ▶ How many boards, panels or tiles are affected, and what size area is affected (roughly)?
- ▶ If some skirting needs replacing, how high is it?
- ▶ If there is dampness showing, do you know where it could be coming from?

Stairs

- ▶ What is the problem: tread or riser loose, squeaking or broken; stair nosing loose or damaged; handrail loose or broken; part of the balustrade missing?
- ▶ If the problem is with the stair nosing, is it made of wood, metal, plastic or rubber?

Advice. Floor coverings inside your home are your responsibility, with the exception of those in kitchens and bathrooms. See page 1 for **Repairs you are responsible for.**

Gutters

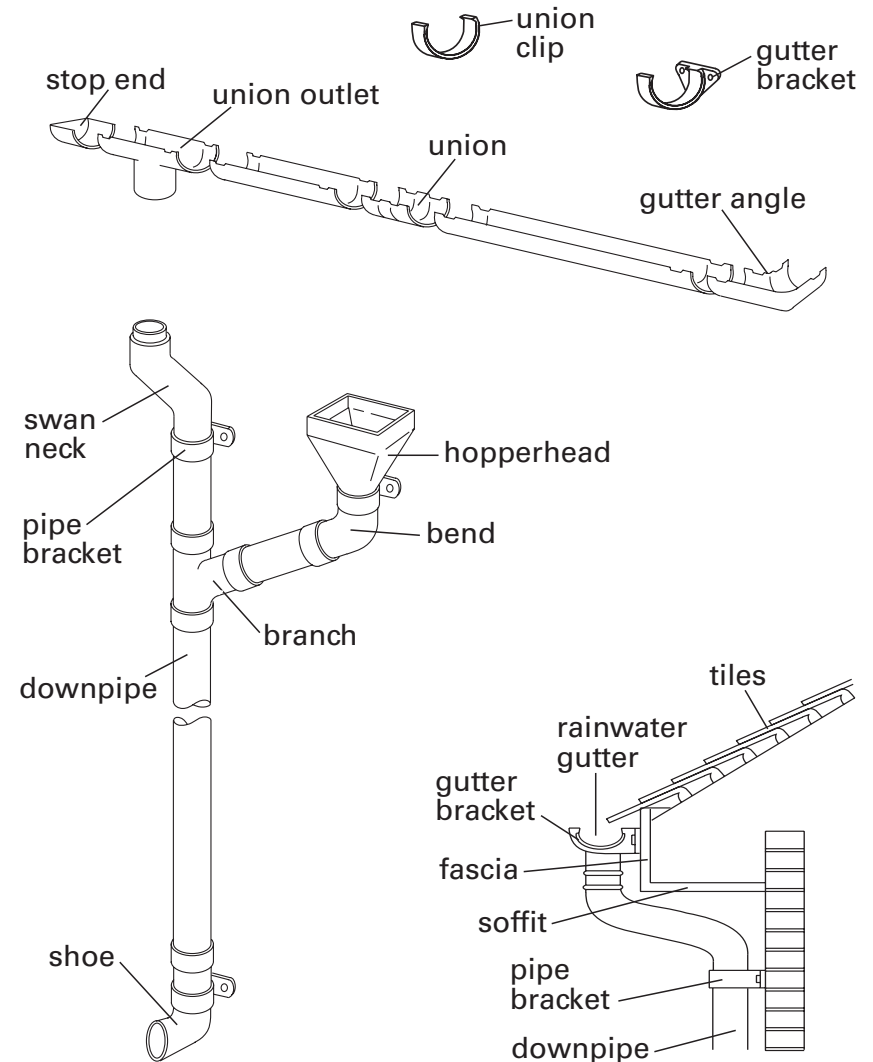

What we need to know

Gutters

- What is the problem: gutter loose, leaking, overflowing (blocked), fallen down, or a part is broken or missing?
- If it is overflowing, where is the water falling from: the gutter or a hopperhead?
- If a part is broken or missing, which part is it?
- If it is a length of guttering, how much is missing (roughly)?
- What is it made of: metal, plastic (upvc) or another material?
- On which side of the building is it: front, back or side?
- How many storeys high is the building?

Rainwater downpipes

- What is the problem: pipe loose, leaking, fallen down or a part is broken or missing?
- If a part is broken or missing, which part is it?
- If it is a length of pipe, how much is missing (roughly)?
- What is it made of: metal, plastic (upvc) or another material?
- On which side of the building is it: front, back or side?
- How many storeys high is the building?

For **gullies** see page 20.

Gutters

Heating

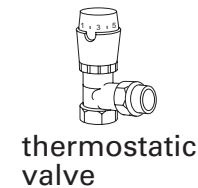
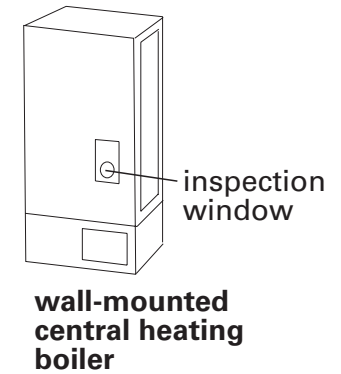
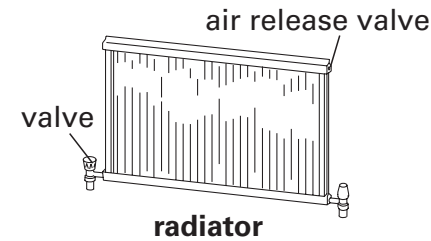

radiator valves

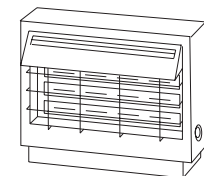
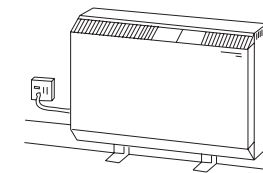
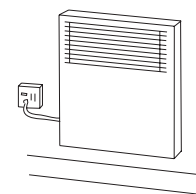
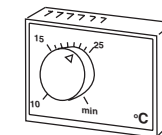
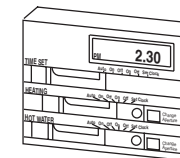
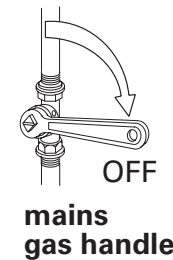

What we need to know

For all heating problems

- ▶ What is the problem: heating not working or not switching on or off at set times, a radiator leaking or not getting warm?
- ▶ What kind of fuel does your system use: gas, electricity, oil, solar energy (from panels) or solid fuel (coal or wood)?
- ▶ Is it a shared heating system where a common boiler is used to heat several homes?
- ▶ If the heating is not working, have you checked:
 - ▶ if the room thermostat has been adjusted? A good temperature is between 18 and 21 degrees
 - ▶ if the boiler or heating appliance has been switched off?
 - ▶ if the gas or electricity supply has been turned off or been cut off for any reason?
 - ▶ the times you have set?

Gas central heating

- ▶ Do you have a boiler? Is it mounted on the wall or standing on the floor?
- ▶ Is it a combination boiler which heats the water instantly when you turn on the hot taps?
- ▶ Do you have radiators, or is it a warm-air system where the heat comes out of vents near the floor?

Electric central heating

- ▶ What kind of heaters do you have: electric space heaters, radiators with water in them, or a warm-air system with vents near the floor?

Stand alone heaters or fires

- ▶ What type is it: gas fire, open wood or coal fire?

For **hot water** see page 38.

Kitchen fittings

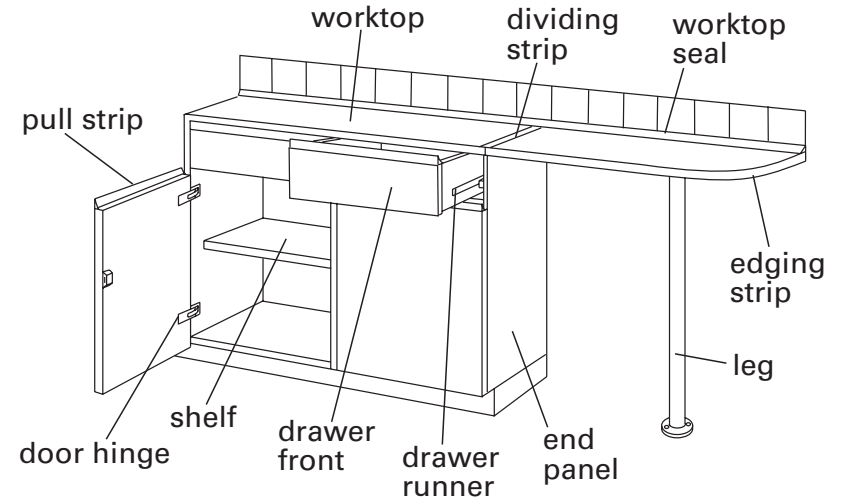

base unit and worktop

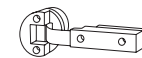

concealed hinge

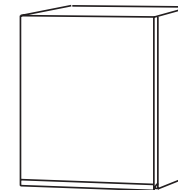

wall unit

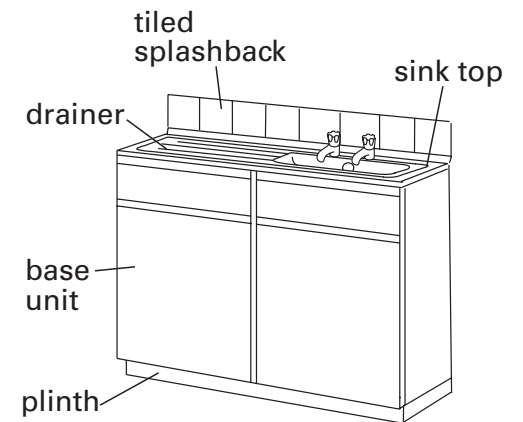

sink unit

What we need to know

Wall and floor units

- What is the problem: wall or floor unit loose or damaged, worktop loose or broken, cupboard door or drawer damaged, cupboard hinge or catch broken?
- What type of unit is it: wall or floor? Is it a tall unit or a corner unit? Is it a single or a double unit?

Sink and worktops

- What is the problem: worktop loose or broken, sink unit damaged or seal around sink leaking?
- If it is a problem with the sink unit, what type is it: is the sink and drainer inset in the worktop or does the metal go right over the edges?

Wall tiles

- What is the problem: tiles fallen off, broken or chipped; seal or grouting damaged or missing?
- What shape are the tiles: square or oblong?
- Are they coloured?
- How many are affected?

Advice. If your tiles are not plain white, we may need longer to source your tiles.

For **taps** and **water** see page 38.

For **wastepipes** and **drains** see page 20.

Roofs and chimneys

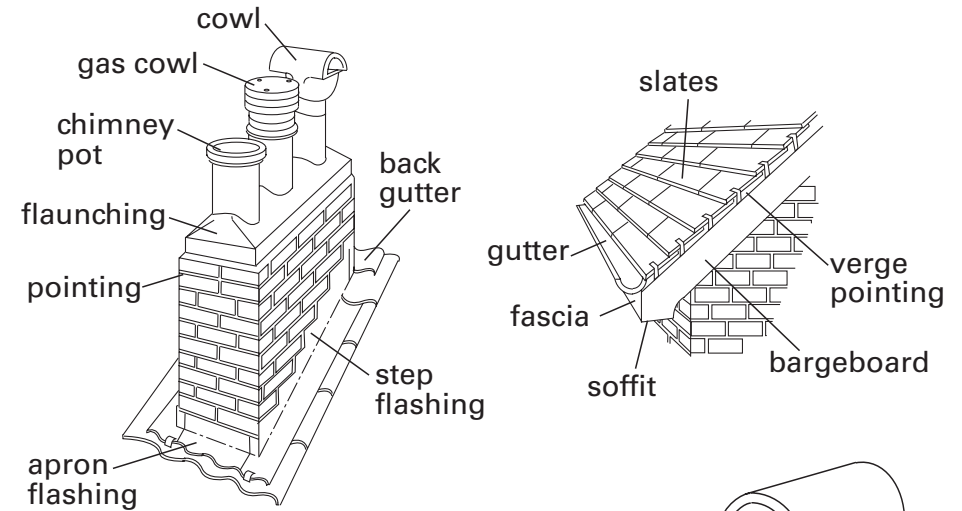

chimney stack



half round ridge tile

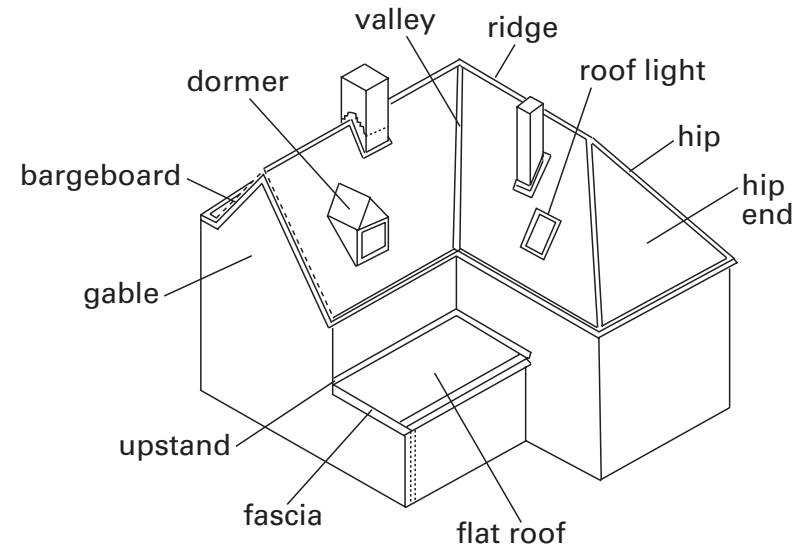

What we need to know

For all roof problems

- What side of the building is the problem: the front, back or side?
- How many storeys high is the building?
- Is there any danger to people?

Roofs and chimneys

- What is the problem: roof leaking; tiles or slates loose or broken; chimney pot or cowl fallen off or loose; chimney stack crumbling?
- If the roof is leaking, where is the water coming through? Can you contain the leak?
- What type of roof is it: flat or sloping?
- Do you know what type of roof covering it is: slates, tiles, corrugated sheeting, or a flat roof with felting or asphalt?
- If it is a problem with corrugated sheeting, what is it made of: plastic, metal or another material?
- If it is a problem with roof tiles, how many are loose or broken?
- If it is a problem with the chimney, is it shared with a neighbouring property?

Roof boarding or wall cladding

- What is the problem: boarding loose, fallen off, broken or rotten?
- Which type of board is it: fascia, soffit or bargeboard?
- What is it made of: plastic or wood?

For **drains** and **gullies** see page 20.

For **gutters** and **downpipes** see page 26.

Toilets

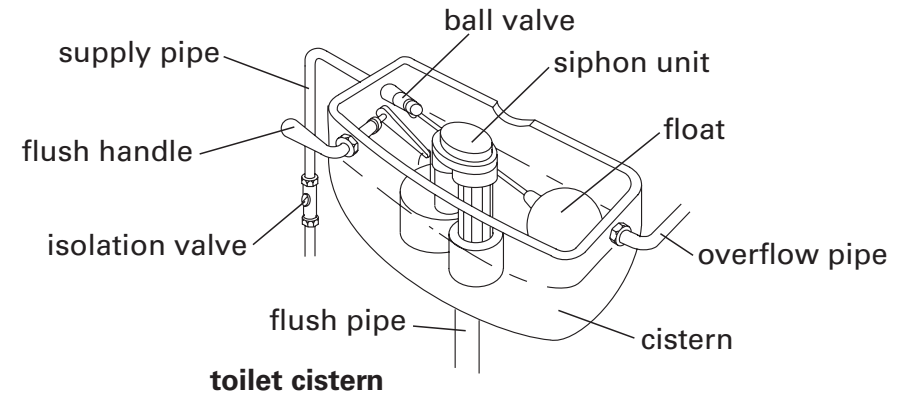

dual-flush button

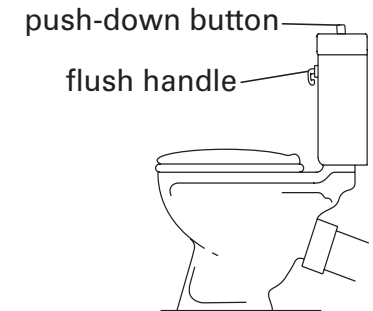

close-coupled toilet

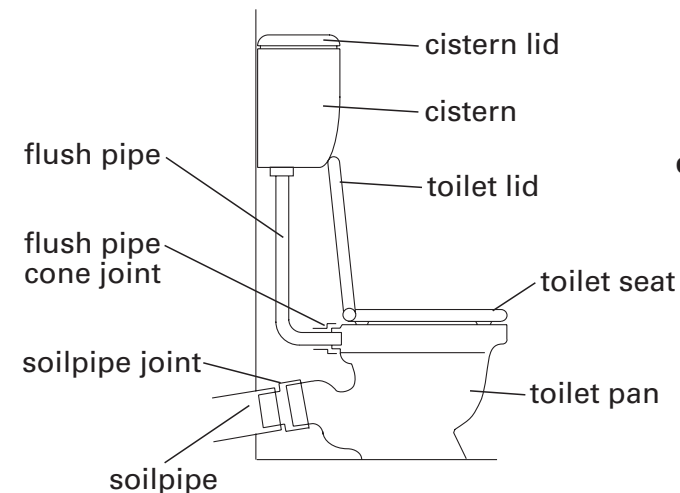

standard toilet

What we need to know

Leaks and blockages

- What is the problem: toilet blocked, cistern leaking, pan leaking, overflow running?
- If the toilet is blocked, do you have another toilet you can use?
- If you are in a block of flats or group of homes, do your neighbours also have blocked toilets? This will be a main drain problem.
- If the toilet or cistern is leaking, where is the leak coming from: a water supply pipe or the flush pipe (clean water) or from the soilpipe (waste water)?

Cistern and pan

- What is the problem: cistern not flushing, flush handle or chain broken, seat loose or broken, pan cracked?
- What type of cistern is it: high-level with chain or low-level? If low-level, what type is it: standard with flush pipe or close-coupled?
- If the pan or cistern is cracked or broken: what colour is it?

Advice. If it is leaking from the soilpipe, make sure you do not use the toilet. If it is leaking from a supply pipe or the flush pipe, put a container under the leak until it is fixed or turn off the supply of water at the isolation valve. For more information, see page 9.

For **drains** see page 20.

For help dealing with blockages, see **Handy hint 1** on page 42.

Walls and ceilings

Inside

a possible cause of dampness is earth mounded over the damp-proof course

damp-proof course

rising damp is usually shown by a 'water' mark to a height of 2-3 feet

damp and mould

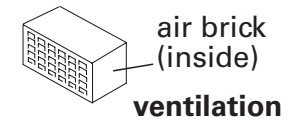

black mould usually shows condensation problems

mould forms

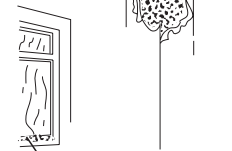

mould forms
condensation

Outside

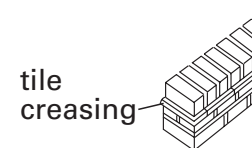
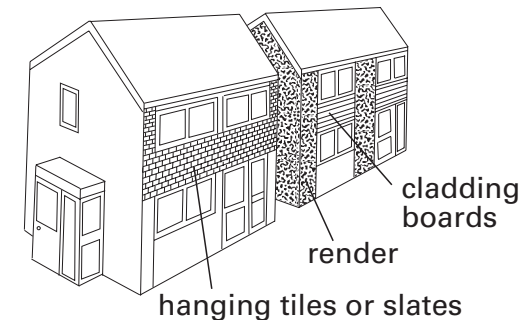

brick on edge coping

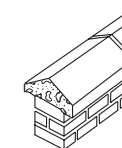

pre-cast concrete coping

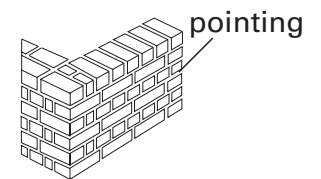

full brick wall

boundary walls

What we need to know

Inside walls and ceilings

- ▶ What is the problem: wall plaster loose or crumbling, ceiling plaster bulging, condensation or mould on walls or ceiling, damp showing through?
- ▶ If there is a water mark or black mould, where is it showing?
- ▶ If the wall is wet, where is it showing? What area is affected?
- ▶ If wall or ceiling plaster is crumbling or bulging, what area is affected?

Outside walls

- ▶ What is the problem: bricks fallen off or crumbling; pointing loose; coping loose, missing or broken; render fallen off; hanging tiles or slates fallen off; boarding loose, broken, rotten or fallen off?
- ▶ What is the wall made of: bricks or concrete blocks?
- ▶ What kind of wall surface does it have: render (pebbledash or smooth), cladding boards, or hanging tiles or slates?

Hanging tiles or slates

- ▶ What is the problem: tiles fallen off, broken or chipped; seal or grouting damaged or missing?
- ▶ What shape are the tiles: square or oblong?
- ▶ How many are affected?

Advice. For information about how to prevent and control condensation, see **Handy hint 3** on page 46.

Walls and ceilings

Water supply and taps

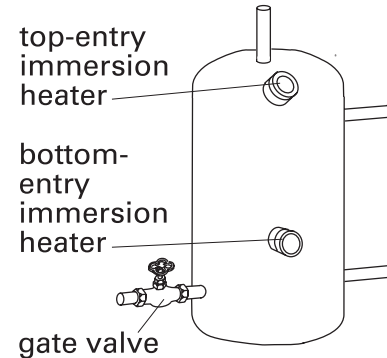

hot water cylinder, no jacket

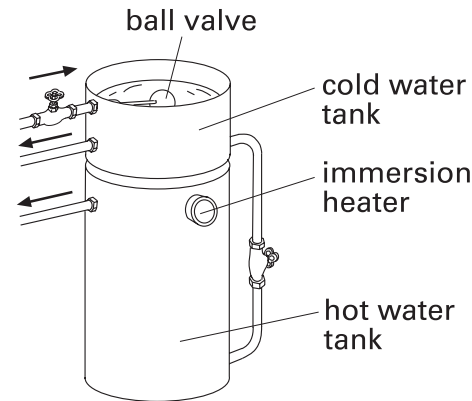

combination tank

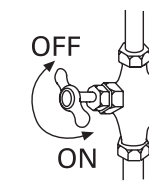

stoptap
(mains water)

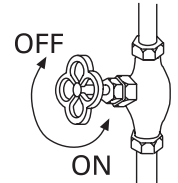

gate valve
(controls part of the system)

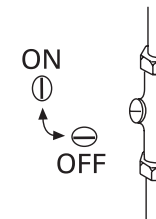

isolation valve

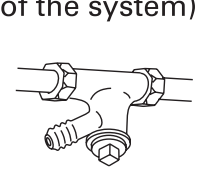

draintap
(drain valve)

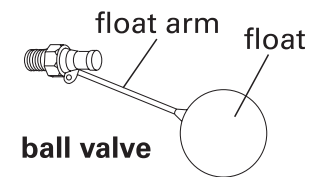

ball valve



combined tap and shower attachment



modern

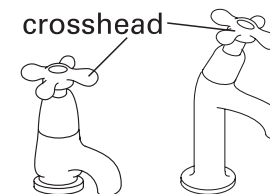

standard pillar taps



high neck



lever tap

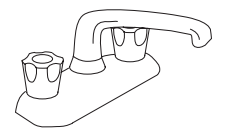

mixer tap

What we need to know

Pipes, taps and leaks

- ▶ What is the problem: pipe leaking; tap dripping, broken or loose; overflow running or broken; water leaking into the home through the ceiling, from the roof space or the flat above?
- ▶ If it is a problem with a tap: is it a hot tap or cold tap? What style of tap is it?
- ▶ If a pipe is leaking, where is the leak?

Water

- ▶ What is the problem: no water supply at all to the home or to part of the home; water coming through taps but not hot; water too hot or water not hot enough?
- ▶ If there is no water coming out of the tap, do you know if neighbouring homes are having the same problem? If so, you need to contact your water supplier. For more information, see page 9.
- ▶ If you have water coming out of the hot tap but it is not hot, have you checked the programmer to see that it is switching on?
- ▶ Do you have a hot water cylinder?

Advice

- ▶ If there is no water coming out of the hot taps, turn off the hot water on your heating programmer or if you use an electric immersion heater (in the hot water cylinder) switch this off at the wall switch.
- ▶ If a pipe is leaking, make sure you shut off the supply of water to it or put a container under the leak until it is fixed. For more information, see page 9.

Windows

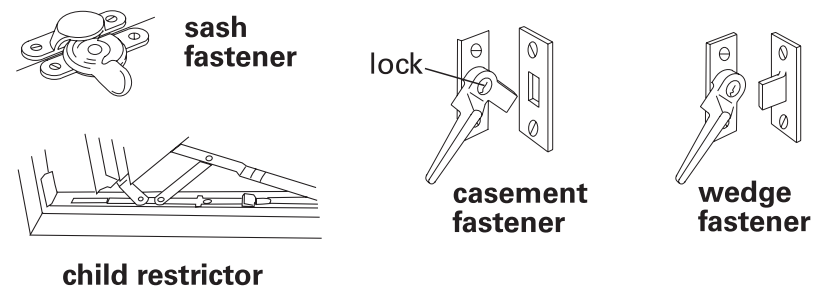
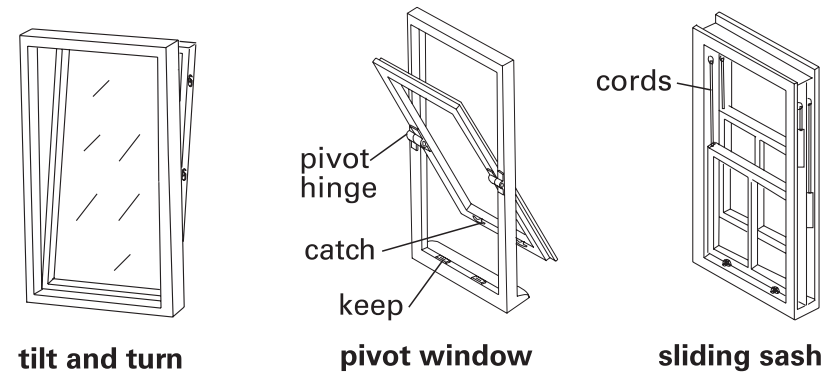
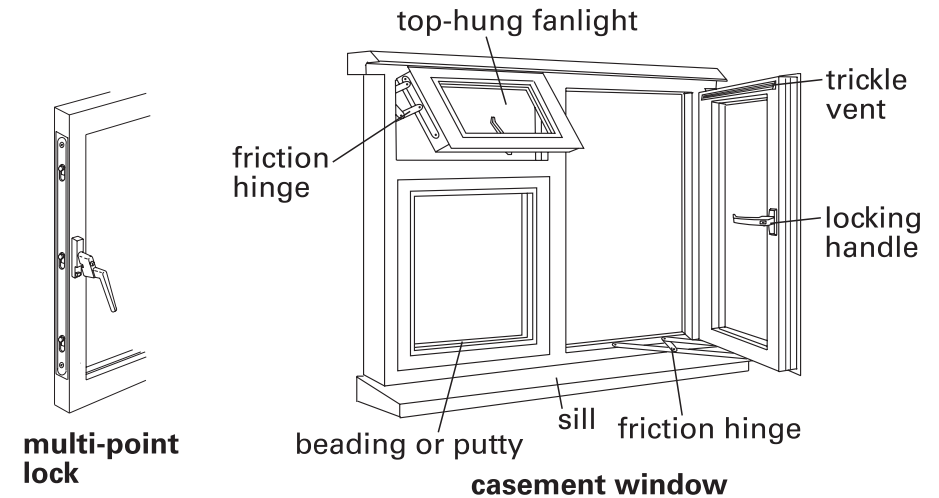

What we need to know

For all window problems

- Where is the window: ground floor, first floor or higher?
- Can you still close the window?

Frames and fasteners

- What is the problem: frame loose, sticking, jammed, damaged or rotten; sash cords broken; fastener broken?
- What is the frame made of: wood, metal or plastic (upvc)?
- What style of frame is it: casement, pivot, tilt and turn, sliding sash?
- If it is draughty, where is the draught coming through: between the wall and the frame, or between the frame and the window?
- What type of fastener is it?

Sills

- What is the problem: sill loose, damaged, rotten or fallen off?
- Which sill is it: inside the home or outside?
- What is the sill made of: wood, tiles, concrete, plastic (upvc) or brick?

Glass

- What is the problem: glass cracked or broken; double glazing misting up between panes; beading (which holds the glass in) loose, broken or missing; putty loose or crumbling?
- What type of glass is it: plain, frosted or wired?
- What size of pane is it (roughly)?
- If you have double glazing, which pane is broken or cracked: the outside or the inside one?

Handy hint 1 - Dealing with blockages: how to unblock a bath, basin, shower, sink or toilet

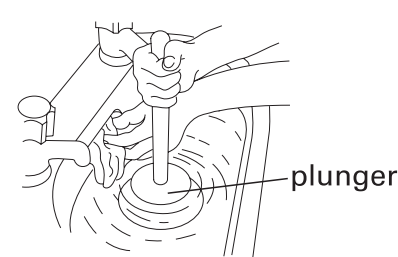

unblocking a basin or sink

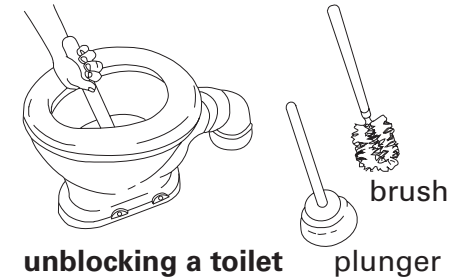

unblocking a toilet



bottle trap

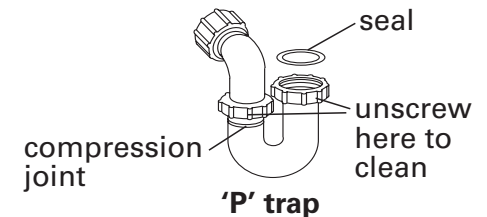

'P' trap

General advice

- The trap always holds some water which stops air or foul smells coming up the drain.
- Blockages are usually caused by the build-up of waste in the trap: cooking oil, fat, nappies, hair and so on. To stop this happening flush wastepipes and traps with hot water regularly. At least once a month use a clearing product to clear them. (**Do not** use caustic soda as it destroys modern plastic fittings).
- If more than one fitting (bath, basin, sink or shower) is blocked, the blockage may be in the soilpipe or main drain. See **Drains, wastepipes and gullies** on page 20. This will need to be cleared by a contractor. Contact us using the details on page 5.

You need:

- ▶ bowl or bucket
- ▶ jug, cup or mug
- ▶ wet cloth
- ▶ plunger - for the toilet you can use a toilet brush
- ▶ rubber gloves.

To unblock a bath, basin or sink:

- ▶ scoop out most of the water
- ▶ hold the cloth tightly over the overflow opening
- ▶ place the plunger over the plug hole and pump it up and down quickly.

To unblock a toilet:

- ▶ if the pan is already full, take out some of the water using some form of scoop (for example a jug, cup or mug) and put this into a bucket
- ▶ push the brush or plunger to the bottom of the pan
- ▶ pump it up and down quickly about 10 times. This should shift the blockage
- ▶ flush the toilet to see whether the blockage has gone
- ▶ you may need to repeat this process several times before the toilet flushes normally. If there is no improvement, you should contact us using the details on page 5.

When you have finished, thoroughly wash your hands and everything you have used.

Handy hint 2 - Resetting a trip switch: how to put the electricity back on when it has 'tripped' off

If your lights or power go off, it means your trip switches are working properly. You will find the trip switches at the consumer unit (or fuse box). The consumer unit is usually next to the electricity meter or near your front or back door.

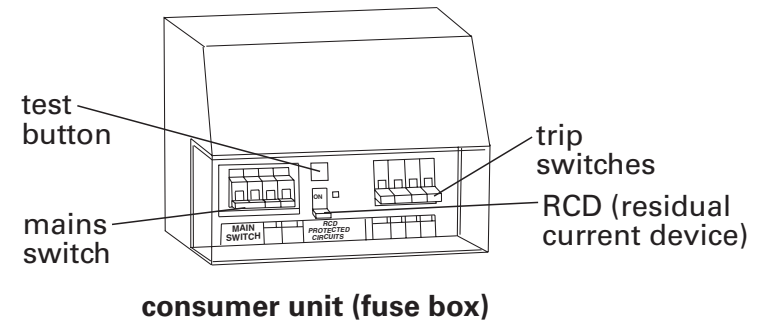

General advice

- ▶ Modern electric circuits are protected by miniature circuit breakers. If there is a problem with an electric circuit, one or more of these will trip out and isolate that circuit.
- ▶ If there is a problem with one of your electrical appliances, leave it unplugged and get a qualified electrician or service engineer to check it.
- ▶ If there is a problem with a light, keep it switched off (put some tape over the switch) and contact us immediately using the details on page 5.
- ▶ Make sure your hands are dry when you touch electrical fittings.

A trip switch or button usually operates because:

- ▶ there are too many fittings or appliances on a circuit and it has been overloaded
- ▶ a power lead to an appliance, such as a TV or hair drier, is damaged or badly connected
- ▶ water has leaked into a circuit or spilt onto a plug
- ▶ a light bulb has blown, or
- ▶ there is a problem with your immersion heater.

To reset a trip switch:

- ▶ open the cover on the consumer unit so you can get at the trip switches or buttons
- ▶ check which switches or buttons have tripped to the OFF position and which rooms (circuit) have been affected
- ▶ switch off all the lights and appliances on the circuit. Then put the trip switch or buttons back to the ON position.

If the trip goes again, it is probably because one of your appliances is faulty. You need to find out which circuit is being affected and which appliance on that circuit is causing the problem.

- ▶ unplug all appliances on the problem circuit, and switch off the immersion heater
- ▶ switch the 'tripped' switch to the ON position (if it is a button press it in)
- ▶ plug in the appliances one at a time until the trip goes again. The last one you plugged in will be the faulty appliance. **Do not** use adaptors when testing appliances.

Do not carry on resetting it if it keeps tripping off. Contact us using the details on page 5.

If, at any point, you do not feel confident to carry out the advice above, please contact us. Do not risk your safety.

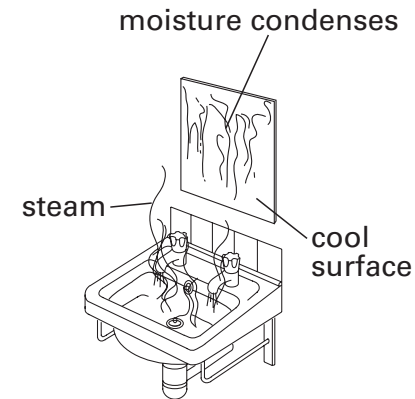
Handy hint 3 - Condensation: how to prevent and control it**What is condensation?**

- ▶ Condensation can occur in any home. You can take steps to prevent it.
- ▶ It starts as moisture or steam that is produced by cooking, washing or drying clothes indoors on radiators.
- ▶ The moist air turns to water (condenses) on cool surfaces such as walls, mirrors, wall tiles and windows, and even some clothes.
- ▶ When the moist air is warm it rises and often ends up on ceilings and in upstairs rooms, and then forms mould.

If mould forms

- ▶ Wipe the mould off immediately with water. **Do not** use washing up liquid.
- ▶ Apply an anti-mould solution to the wall. You can get this from a hardware shop or DIY store. Read the instructions carefully before using it. Also, wear rubber gloves. **Do not** use bleach.

Control excess moisture

- ▶ Close kitchen and bathroom doors to prevent steam going into other, colder rooms.
- ▶ Open kitchen and bathroom windows when cooking or washing (and for a while after) so that steam can escape, or use an extractor fan if you have one fitted.
- ▶ Open some windows in other rooms for a while each day to allow a change of air.
- ▶ Do not use bottled gas heaters - the gas produces a lot of moisture.
- ▶ Prevent mould forming by wiping down surfaces where moisture settles, for example window sills or frames.
- ▶ Do not block air vents.

Produce less moisture

- ▶ Dry clothes outdoors whenever possible, otherwise use well ventilated rooms.
- ▶ Cover pans when cooking.
- ▶ Vent any tumble driers to the outside.
- ▶ Cover fish tanks and remember houseplants and pets also produce moisture.

Keep your house warm

- ▶ Take steps to prevent heat escaping your home.
- ▶ Keep your heating on all the time on a low setting when the weather is cold or very wet. This does not necessarily cost more than switching it on and off.

Please contact us if you need any part of this information in Braille, on audio tape or explained in a different language.

Afsoomaali Español العربية ትግርኛ
বাংলা Français Português Shqip فارسی

No part of this document may be reproduced or transmitted in any form or by any means, electronic or mechanical, including photocopying, recording, or by any information storage or retrieval system without prior permission in writing from Omfax Ltd.

Designed and developed for Octavia Housing Ltd by Omfax Systems Limited, 21 The Causeway, Bicester, Oxon OX26 6AN www.omfax.co.uk © OMFAX LTD 2014



OCTAVIA

Supporting mixed communities since 1865



Octavia
Emily House
202-208 Kensal Road
London W10 5BN

T 020 8354 5500
F 020 8354 4280
E info@octavia.org.uk
www.octavia.org.uk